

# 見苦しいシート表面へのキズつきを防ぎます

Lexan\* Margard\*シートには独自のハードコーティングが施されており、摩擦によるキズつきを高いレベルで防ぎます。シート表面への接触が多い用途に適した材料です。

## 高い耐摩耗性

テーバー摩耗試験 (ASTM-1044 / ISO 3575) は、耐摩耗性を検査するための試験です。この試験は、荷重 (通常500グラム) をかけた金属輪を試料面上で所定の回数回転させておこないます。

回転数は、一般的には100回転または500回転です。試験後、ヘイズ率をパーセントで算出します。ヘイズ率には、試料の光透過性の低減度合いが直接反映されます。テーバー試験は、「摩耗の激しい環境」における素材の耐擦傷性能を予測するための優れた試験です。ヘイズ値が高いほど、耐摩耗性は低くなります。



素材	ヘイズ (100回転)	ヘイズ (500回転)
ガラス	2%	2%
Lexan Margard MRA3シート	3%	4%
Lexan Margard MR5Eシート	3%	9%
Lexan Margard FMR5 XTシート	9%	25%
Lexan 9030/Exell Dシート	25%	35%
アクリル	25%	35%
PVC	30%	36%

## テーバー摩耗試験

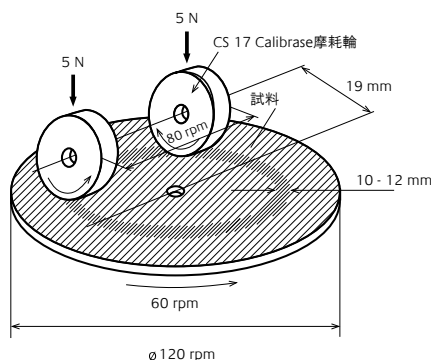
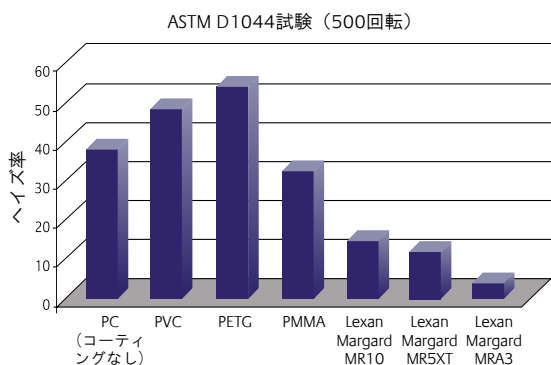

# Lexan\* Margard\* sheet scratch resistance



## Samples after 500 rotations

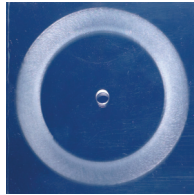

Lexan 9030 sheet

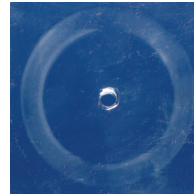

Glass

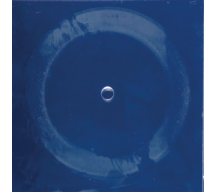

Lexan Margard MR5E sheet

## Samples after 100 rotations

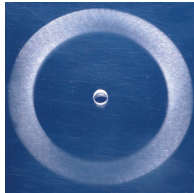

Lexan 9030 sheet

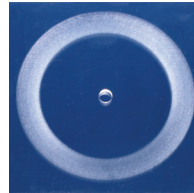

Acrylic

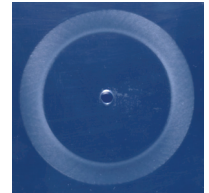

Lexan Margard FMR5XT sheet

### Americas

SABIC Innovative Plastics  
Specialty Film & Sheet  
One Plastics Avenue  
Pittsfield, MA 01201  
USA  
T 800 451 3147  
T 413 448 5400  
F 413 448 7506

### Europe

SABIC Innovative Plastics  
Specialty Film & Sheet  
Plasticslaan 1  
PO Box 117  
4600 AC  
Bergen op Zoom  
The Netherlands  
T +31 164 292911  
F +31 164 292940

### Pacific

SABIC Innovative Plastics  
Specialty Film & Sheet  
1266 Nanjing Road (W)  
Unit 902-907, Plaza 66  
200040 Shanghai  
China  
T +86 21 3222 4500  
F +86 21 6289 8998

### Email

sfs.info@sabic-ip.com



\*Trademark of SABIC Innovative Plastics IP BV

THE MATERIALS, PRODUCTS AND SERVICES OF SABIC INNOVATIVE PLASTICS HOLDING BV, ITS SUBSIDIARIES AND AFFILIATES ("SELLER"), ARE SOLD SUBJECT TO SELLER'S STANDARD CONDITIONS OF SALE, WHICH CAN BE FOUND AT <http://www.sabic-ip.com> AND ARE AVAILABLE UPON REQUEST. ALTHOUGH ANY INFORMATION OR RECOMMENDATION CONTAINED HEREIN IS GIVEN IN GOOD FAITH, SELLER MAKES NO WARRANTY OR GUARANTEE, EXPRESS OR IMPLIED, (i) THAT THE RESULTS DESCRIBED HEREIN WILL BE OBTAINED UNDER END-USE CONDITIONS, OR (ii) AS TO THE EFFECTIVENESS OR SAFETY OF ANY DESIGN INCORPORATING SELLER'S PRODUCTS, SERVICES OR RECOMMENDATIONS. EXCEPT AS PROVIDED IN SELLER'S STANDARD CONDITIONS OF SALE, SELLER SHALL NOT BE RESPONSIBLE FOR ANY LOSS RESULTING FROM ANY USE OF ITS PRODUCTS OR SERVICES DESCRIBED HEREIN. Each user is responsible for making its own determination as to the suitability of Seller's products, services or recommendations for the user's particular use through appropriate end-use testing and analysis. Nothing in any document or oral statement shall be deemed to alter or waive any provision of Seller's Standard Conditions of Sale or this Disclaimer, unless it is specifically agreed to in a writing signed by Seller. No statement by Seller concerning a possible use of any product, service or design is intended, or should be construed, to grant any license under any patent or other intellectual property right of Seller or as a recommendation for the use of such product, service or design in a manner that infringes any patent or other intellectual property right.

SABIC Innovative Plastics is a trademark of SABIC Holding Europe BV

\* Lexan and Margard are trademarks of SABIC Innovative Plastics IP BV

© Copyright 2008 SABIC Innovative Plastics IP BV. All rights reserved.